

6W

INDUCTION MOTOR, REVERSIBLE MOTOR
 □ 60mm TERMINAL BOX TYPE

INDUCTION MOTOR - CONTINUOUS RATING

SIZE mm sq.	Type	Poles	Output (W)	Voltage (V)	Frequency (Hz)	Duty	Rated Load				Starting Torque		Capacitor (uF)
							Current (A)	Speed (rpm)	Torque (kg-cm) (N-m)		(kg-cm)	(N-m)	
60	S6I06GA-T	4	6	1 ∅ 110	60	Cont.	0.20	1550	0.40	0.040	0.55	0.055	2.5
	S6I06GB-T	4	6	1 ∅ 220	60	Cont.	0.10	1550	0.40	0.040	0.55	0.055	0.7
	S6I06GC-T	4	6	1 ∅ 100	50	Cont.	0.21	1200	0.50	0.050	0.45	0.045	2.5
					60		0.19	1500	0.42	0.042			
	S6I06GD-T	4	6	1 ∅ 200	50	Cont.	0.10	1200	0.50	0.050	0.45	0.045	0.7
					60			1500	0.42	0.042			
	S6I06GE-T	4	6	1 ∅ 100	50	Cont.	0.18	1200	0.50	0.050	0.52	0.052	2.5
					60		0.19	1500	0.42	0.042			
					60		0.19	1500	0.42	0.042			
	S6I06GX-T S6I06GX-TCE	4	6	1 ∅ 220	50	Cont.	0.08	1200	0.50	0.050	0.50	0.050	0.6
0.09							0.53		0.053	0.55	0.055		
1 ∅ 240							0.50		0.050	0.55	0.055		

- ❖ Appropriate capacitors shall be used according to the voltage for S6I06GE-T type since the size of the capacitor differs by different voltages. Malfunction may occur when not used properly. Capacitor for 115V will be delivered otherwise the required voltage is informed.
- ❖ CE marked at the end of the model name indicates that it is impedance protected type which has received CE.
- ❖ "L" or "H" type does not apply to motors under 40W.

REVERSIBLE MOTOR - 30MINUTES RATING

SIZE mm sq.	Type	Poles	Output (W)	Voltage (V)	Frequency (Hz)	Duty	Rated Load				Starting Torque		Capacitor (uF)
							Current (A)	Speed (rpm)	Torque (kg-cm) (N-m)		(kg-cm)	(N-m)	
60	S6R06GA-T S6R06GA-TCE	4	6	1 ∅ 110	60	30min.	0.22	1550	0.40	0.040	0.60	0.060	3.0
	S6R06GB-T S6R06GB-TCE	4	6	1 ∅ 220	60	30min.	0.11	1550	0.40	0.040	0.60	0.060	0.8
	S6R06GC-T S6R06GC-TCE	4	6	1 ∅ 100	50	30min.	0.21	1200	0.50	0.050	0.45	0.045	3.0
					60			1500	0.42	0.042			
	S6R06GD-T S6R06GD-TCE	4	6	1 ∅ 200	50	30min.	0.10	1200	0.45	0.045	0.53	0.053	0.8
					60			1500	0.42	0.042			
	S6R06GE-T S6R06GE-TCE	4	6	1 ∅ 100	50	30min.	0.19	1200	0.50	0.050	0.52	0.052	3.5
					60		0.22	1500	0.30	0.030			
					60		0.18	1500	0.42	0.042			
	S6R06GX-T S6R06GX-TCE	4	6	1 ∅ 220	50	30min.	0.09	1200	0.47	0.047	0.50	0.050	0.7
0.10							0.50		0.050	0.55	0.055		
1 ∅ 240	0.50	0.050	0.55	0.055									

- ❖ Appropriate capacitors shall be used according to the voltage for S6R06GE-T type since the size of the capacitor differs by different voltages. Malfunction may occur when not used properly. Capacitor for 115V will be delivered otherwise the required voltage is informed.
- ❖ CE marked at the end of the model name indicates that it is impedance protected type which has received CE. S6R06GE-TCE is available only for 115V specification.
- ❖ Above data is measured with friction brake mounted.
- ❖ "L" or "H" type does not apply to motors under 40W.

50Hz

GEAR RATIO		3	3.6	5	6	7.5	9	10	12.5	15	18	20	25	30	36	40	50	60	75	90	100	120	150	180	200	250
MODEL	rpm	500	416	300	250	200	166	150	120	100	83	75	60	50	41	37	30	25	20	16	15	12	10	8	7.5	6
	kg-cm	1.3	1.5	2.1	2.6	3.2	3.9	4.3	5.4	6.4	7.7	7.7	9.7	11.6	13.9	15.5	17.5	21.0	26.2	30.0	30.0	30.0	30.0	30.0	30.0	30.0
S6DA□B		Nm	0.127	0.147	0.206	0.255	0.314	0.382	0.421	0.529	0.627	0.755	0.755	0.951	1.137	1.362	1.519	1.715	2.058	2.568	2.942	2.942	2.942	2.942	2.942	2.942

60Hz

GEAR RATIO		3	3.6	5	6	7.5	9	10	12.5	15	18	20	25	30	36	40	50	60	75	90	100	120	150	180	200	250
MODEL	rpm	600	500	360	300	240	200	180	144	120	100	90	72	60	50	45	36	30	24	20	18	15	12	10	9	7.2
	kg-cm	1.0	1.3	1.7	2.1	2.6	3.1	3.5	4.4	5.2	6.3	6.3	7.8	9.4	11.3	12.6	14.2	17.0	21.3	25.5	28.4	30.0	30.0	30.0	30.0	30.0
S6DA□B		Nm	0.098	0.127	0.167	0.206	0.255	0.304	0.343	0.431	0.510	0.617	0.617	0.764	0.921	1.107	1.235	1.392	1.666	2.087	2.499	2.783	2.942	2.942	2.942	2.942

- ❖ The code in □ of gearhead model is for gear ratio.
- ❖ It is the permissible torque of the assembled motor and gearhead.
- ❖ The permissible torque of the motor and inter-decimal gearhead is 30 kg-cm.
- ❖ ■ color indicates that the output shaft of the geared motor rotates in the same direction as the output shaft of the motor. Others indicate rotation in the opposite direction.
- ❖ Rpm is based on synchronous speed (50Hz: 1500rpm, 60Hz: 1800rpm) divided by gear ratio.
The actual rotation speed can be 2~20% less than displayed value depending on the load.
- ❖ "L" or "H" type does not apply to motors under 40W.

DIMENSIONS

GEARED MOTOR

* MOTOR MODEL : S6(I,R)06G□-T
 * HEAD MODEL : S6□A3□~S6□A250□

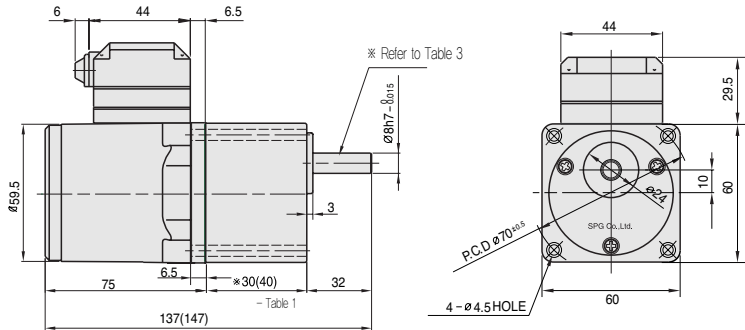

INTER-DECIMAL GEAR HEAD

* MODEL : S6GX10B

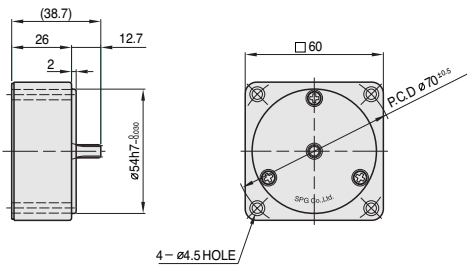

MOTOR

* MOTOR MODEL : S6(I,R)06□□-T

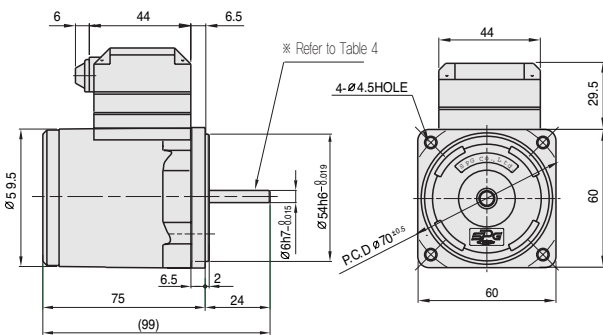

*30(40) - (Table 1)

GEAR RATIO	SIZE(mm)
S6□A3□ ~ S6□A18□	30
S6□A20□ ~ S6□A250□	40

WEIGHT - (Table 2)

PART	WEIGHT(kg)	
MOTOR	0.76	
REVERSIBLE MOTOR	0.77	
DECIMAL GEAR HEAD	0.18	
GEAR HEAD	S6□A3□ ~ S6□A18□	0.24
	S6□A20□ ~ S6□A40□	0.30
	S6□A50□ ~ S6□A250□	0.33

SPEC for output shaft of gearhead - (Table 3)

MODEL	TYPES OF OUTPUT SHAFT
STRAIGHT TYPE S6SA3□ ~ S6SA250□	
D-CUT TYPE S6DA3□ ~ S6DA250□	
KEY TYPE S6KA3□ ~ S6KA250□	

SPEC for output shaft of motor - (Table 4)

MODEL	TYPES OF OUTPUT SHAFT
GEAR TYPE S6(I,R)06G□-T	
STRAIGHT TYPE S6(I,R)06S□-T	
D-CUT TYPE S6(I,R)06S□-T	

KEY SPEC

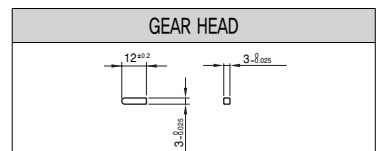

SCHEMATIC DIAGRAMS

The direction of motor rotation is as viewed from the front shaft end of the motor.
 Circled number is the terminal number inside terminal box.

INDUCTION MOTOR

S6I06GA-T S6I06GB-T
 S6I06GC-T S6I06GD-T
 S6I06GE-T

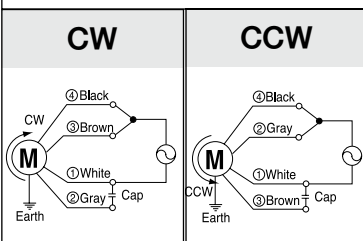

REVERSIBLE MOTOR

S6R06GA-T S6R06GB-T
 S6R06GC-T S6R06GD-T
 S6R06GA-TCE S6R06GB-TCE S6R06GC-TCE
 S6R06GD-TCE S6R06GE-T S6R06GE-TCE

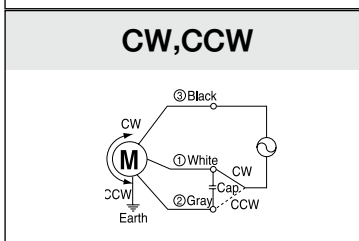

S6R06GX-TCE
 S6R06GX-T

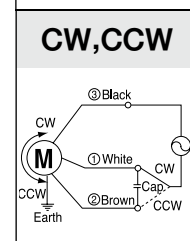

Change the direction of motor rotation only after the motor stops completely. If an attempt is made to change the direction of rotation while the motor is running, the motor may ignore the reversing command or change its direction of rotation after some delay.